

Block Diagram

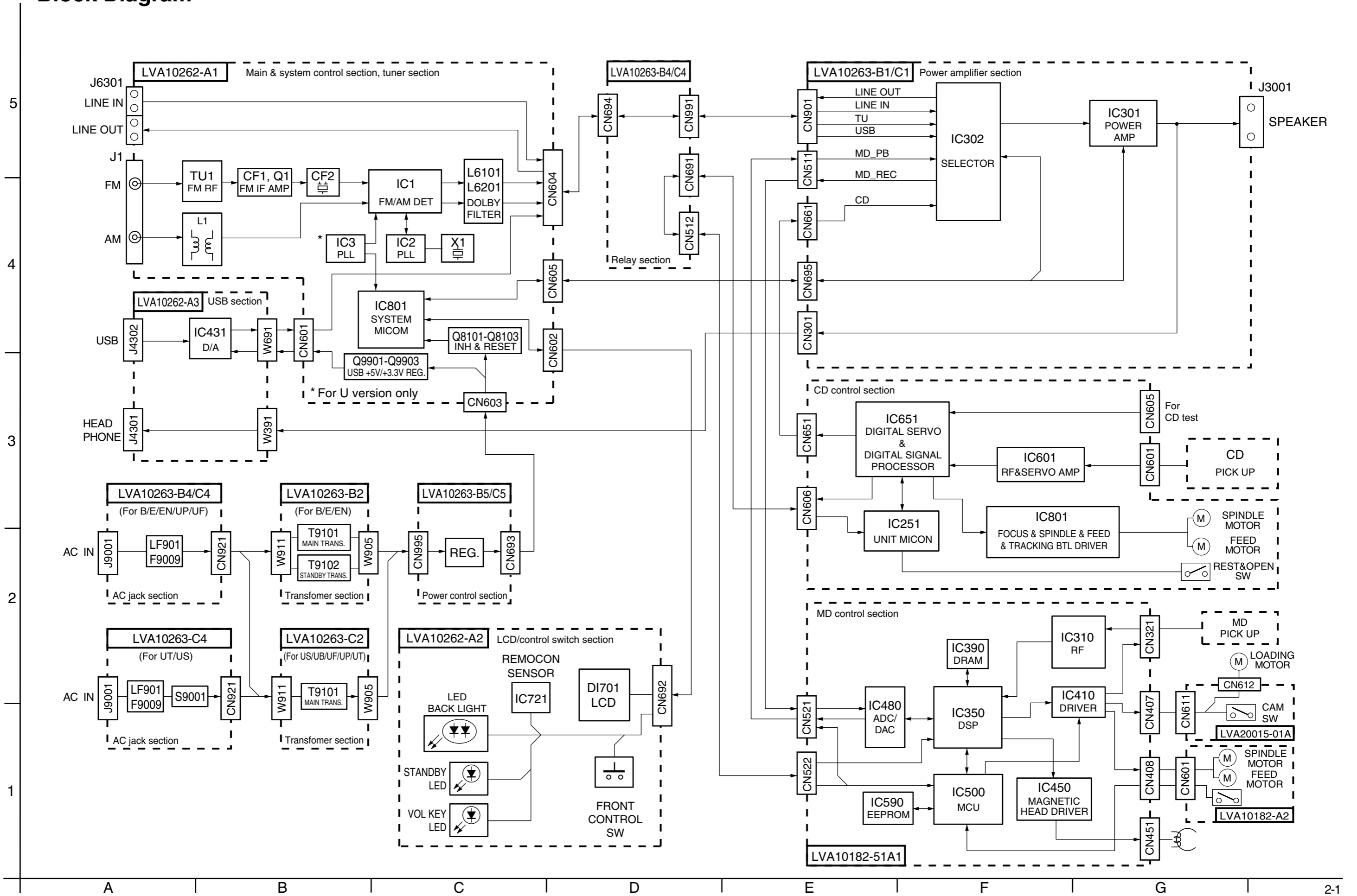

Standard schematic diagrams

System control, LCD/control swith,headphone & USB section

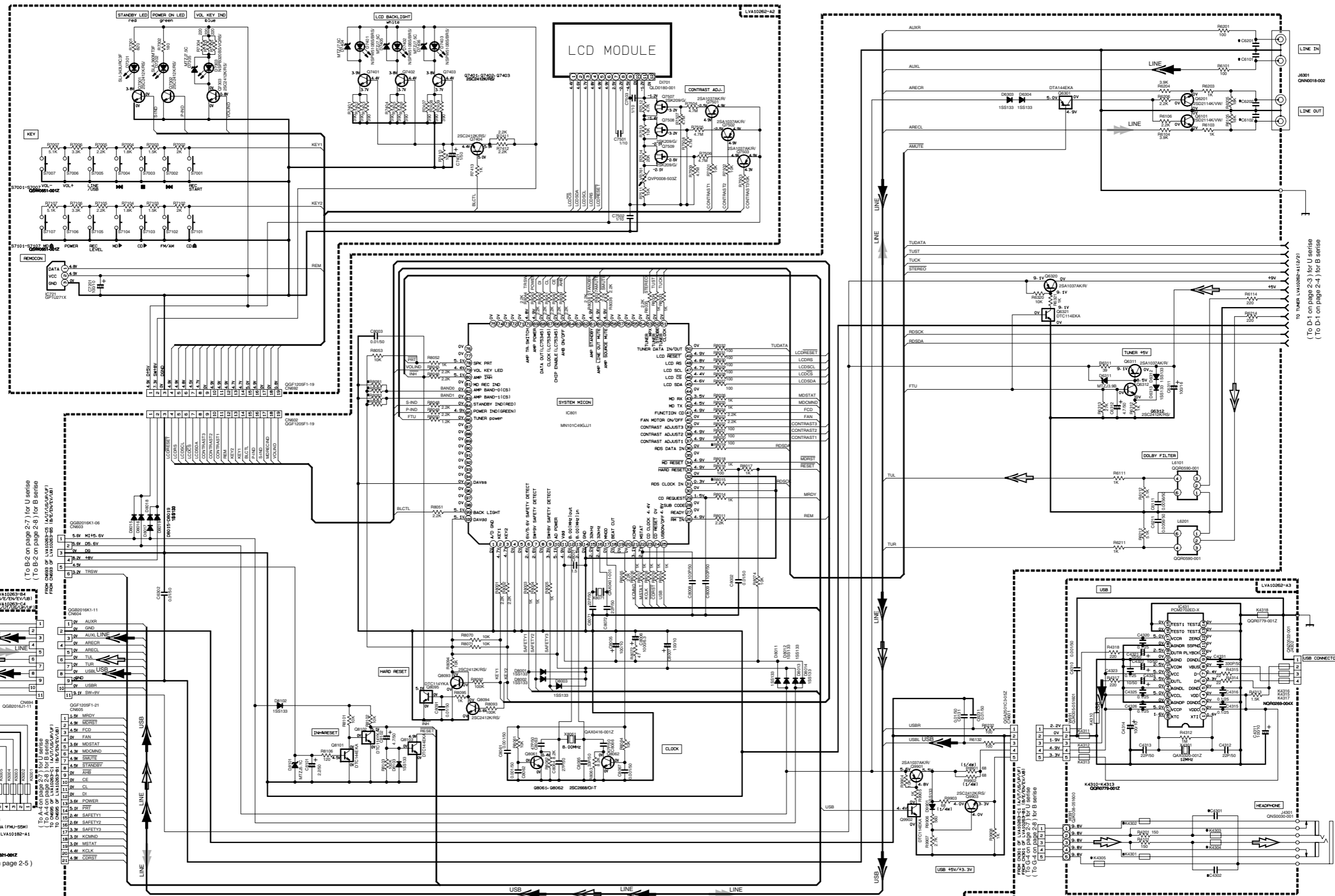

MARKS	REF NO.	RB081	RB082	RB083	RB084	RB015	OB101	OB102	K4303	K4305	C4301	K4301
VERSION		10K	NONE	NONE	2.2K	1K	150P	150P	NPQ2069-004R	47P	99R0521-001Z	
A/UT/S/UP/V/F		NONE	2.2K	10K	NONE	NONE	NONE	NONE	SHORT	NONE	SHORT	

2- UNLESS OTHERWISE SPECIFIED.
 CONDITION-CD STOP MODE.
 RESISTORS ARE 1/16W 45% METAL GLAZE RESISTOR.
 ALL RESISTANCE VALUES ARE IN OHM (Ω).
 ALL CAPACITORS ARE CERAMIC CAPACITOR OR MYLAR CAPACITOR.
 ALL CAPACITANCE VALUES ARE IN pF (pF).
 ALL INDUCTANCE VALUES ARE IN μH (μH).
 ALL CAPACITORS ARE SHOWN IN THE FORM RESET OF INH CAPACITANCE (1/F)/RATED VOLTAGE (V).

- ➡ RADIO SIGNAL
- ➡ LINE
- ➡ INPUT SIGNAL (LINE IN)
- ➡ INPUT SIGNAL (USB)
- ➡ OUTPUT SIGNAL (LINE OUT)
- ➡ MAIN SIGNAL

5
4
3
2
1

A B C 2-2 D E F G H

(To B-2 on page 2-7) for U serise
 (To A-5 on page 2-8) for B serise
 (To G-4 on page 2-5) for U serise
 (To D-1 on page 2-3) for B serise

■ Tuner section (A/US/UB/UP version)

NOTES

1. VOLTAGES ARE DC-MEASURED WITH A DIGITAL VOLT METER.
2. ALL RESISTORS ARE 1/8W ±5% METAL GLAZE RESISTOR.
3. ALL RESISTANCE VALUES ARE IN OHM(Ω).
4. ALL CAPASITANCE VALUES ARE IN #F(P=PF).
5. ALL E. CAPASITORS ARE SHOWN IN THE FORM OF CAPASITANCE (#F)/RATED VOLTAGE (V).
6. SI DIODES (⚡) ARE ALL 1SS133-T THAT CAN BE CHANGED TO SIMILAR DIODE SUCH AS MA165 OR HSS104J.
7. PARTS NO. OF TRANSISTORS ARE AS FOLLOWS:
Q1 2SC2814/4-5/-X Q2, Q3 2SC2412K/R/-X
Q4, Q5 DTA114YKA-X

8. INSIDE OF DIGITAL TRANSISTORS ARE SHOWN AS FOLLOWS:

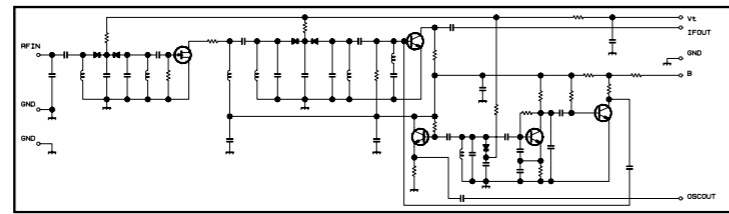
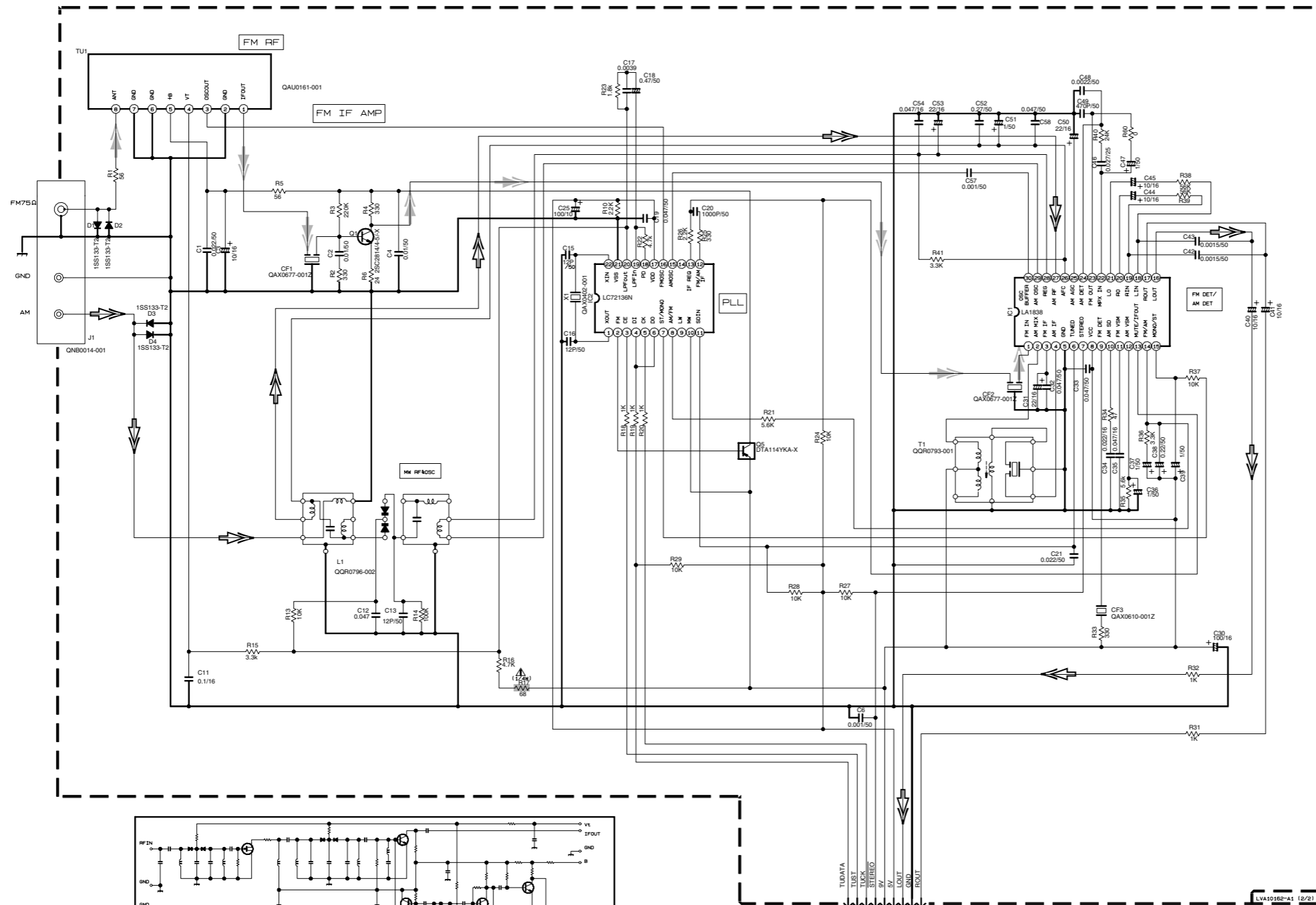
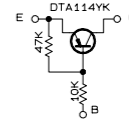

CONDITION	PIN NO.	1	2	3	4	5	6	7	8	9	10	11	12	13	14	15	16	17	18	19	20	21	22	23	24	25	26	27	28	29	30
IC1	FM NO SIGNAL	3.6	8.9	3.6	3.6	0	5.0	5.0	8.9	8.9	1.3	0.1	0	0.9	7.8	7.8	4.3	4.3	4.3	4.3	3.4	3.4	2.8	3.4	0	0	3.5	3.5	3.6	3.6	2.7
IC1	FM 60dB STEREO	3.6	8.9	3.6	3.6	0	5.0	5.0	8.9	8.9	1.3	4.3	0	0.9	7.8	7.8	4.3	4.3	4.3	4.3	3.4	3.4	2.8	3.4	0	0	3.6	3.6	3.6	3.6	2.7
IC1	AM NO SIGNAL	3.5	9.0	3.5	3.5	0	5.0	5.1	9.0	2.6	1.3	0	0	0.9	4.7	5.5	4.3	4.3	4.3	4.3	3.3	3.2	2.8	ust	0.7	0.7	3.6	3.6	3.6	3.6	2.1
IC2	FM NO SIGNAL	2.5	0	0	5.0	4.9	5.0	7.9	7.8	3.6	6.1	5.1	0	0	0	0	2.5	5.1	0.9	0.9	3.8	0	2.3								

Tr. NO.	Q1	Q5				
PIN NO.	E	C	B	E	C	B
FM 87.5MHZ NO SIGNAL	0	7.1	0.65	8.9	8.8	0
AM 522KHZ NO SIGNAL	0	0	0	9.0	0	8.9
Tr. NO.	Q2			Q3		
PIN NO.	E	C	B	E	C	B
AM 522KHZ NO SIGNAL	0	0	0.7	0	0	0.7
	0	3.6	0.7	0	3.6	0.7

▲ Parts are safety assurance parts. When replacing those parts make sure to use the specified one.

➡ FM signal

➡ AM/RADIO signal

5
4
3
2
1

■ Tuner section (B/E/EN version)

NOTES

- VOLTAGES ARE DC-MEASURED WITH A DIGITAL VOLT METER.
- ALL RESISTORS ARE 1/8W ±5% METAL GLAZE RESISTOR.
- ALL RESISTANCE VALUES ARE IN OHM(Ω).
- ALL CAPASITANCE VALUES ARE IN μF(P=pF).
- ALL E. CAPASITORS ARE SHOWN IN THE FORM OF CAPASITANCE (μF)/RATED VOLTAGE (V).
- SI DIODES (▶) ARE ALL 1S5133-T THAT CAN BE CHANGED TO SIMILAR DIODE SUCH AS MA165 OR HSS104J.
- PARTS NO. OF TRANSISTORS ARE AS FOLLOWS:
Q1 2SC2B14/4-5/-X Q2-Q3 2SC2412K/R/-X
Q4-Q5 DTA114YKA-X

B. INSIDE OF DIGITAL TRANSISTORS ARE SHOWN AS FOLLOWS:

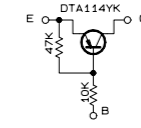

5
4
3
2
1

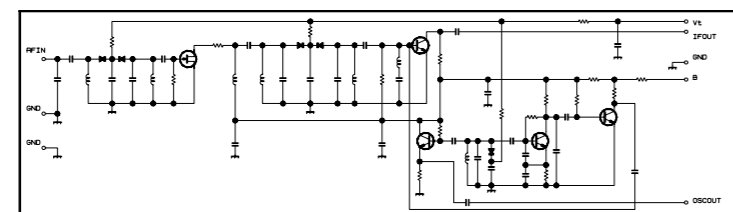
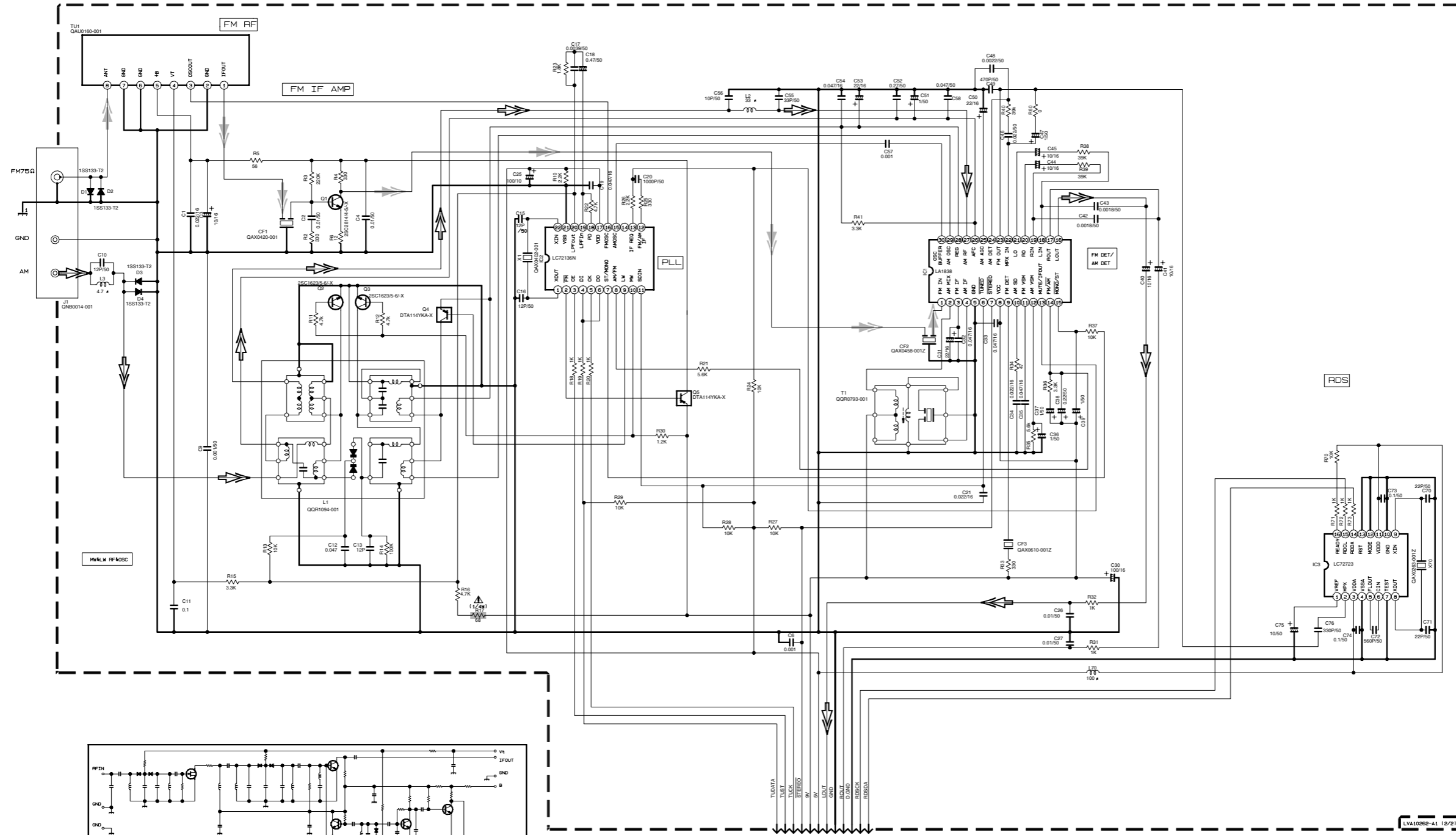

CONDITION	PIN NO.	1	2	3	4	5	6	7	8	9	10	11	12	13	14	15	16	17	18	19	20	21	22	23	24	25	26	27	28	29	30
IC1	FM NO SIGNAL	3.6	8.9	3.6	3.6	0	5.0	5.0	8.9	8.9	1.3	0.1	0	0.9	7.8	7.8	4.3	4.3	4.3	4.3	3.4	3.4	2.8	3.4	0	0	3.5	3.5	3.6	3.6	2.7
IC1	FM 60dB STEREO	3.6	8.9	3.6	3.6	0	5.0	5.0	8.9	8.9	1.3	4.3	0	0.9	7.8	7.8	4.3	4.3	4.3	4.3	3.4	3.4	2.8	3.4	0	0	3.6	3.6	3.6	3.6	2.7
IC1	AM NO SIGNAL	3.5	9.0	3.5	3.5	0	5.0	5.1	9.0	2.6	1.3	0	0	0.9	4.7	5.5	4.3	4.3	4.3	4.3	3.3	3.2	2.8	UST	0.7	0.7	3.6	3.6	3.6	3.6	2.1
IC2	FM NO SIGNAL	2.5	0	0	5.0	4.9	5.0	7.9	7.8	3.6	6.1	5.1	0	0	0	0	2.5	5.1	0.9	0.9	3.8	0	2.3								

Tr. NO.	Q1	Q5
PIN NO.	E C B	E C B
FM 87.5MHz NO SIGNAL	0 7.1 0.85	8.9 8.9 0
AM 522kHz NO SIGNAL	0 0 9.0	0 8.9

Tr. NO.	Q2	Q3	Q4
PIN NO.	E C B	E C B	E C B
AM 522kHz NO SIGNAL	0 0 0.7	0 0 0.7	0 3.6 0.7
AM 144kHz NO SIGNAL	0 0 0.3	0 0.3 0.3	3.6 3.6 3.6

▲ Parts are safety assurance parts. When replacing those parts make sure to use the specified one.

→ FM SIGNAL
⇨ AM/RADIO SIGNAL

A B C 24 D E F G H

MD control section

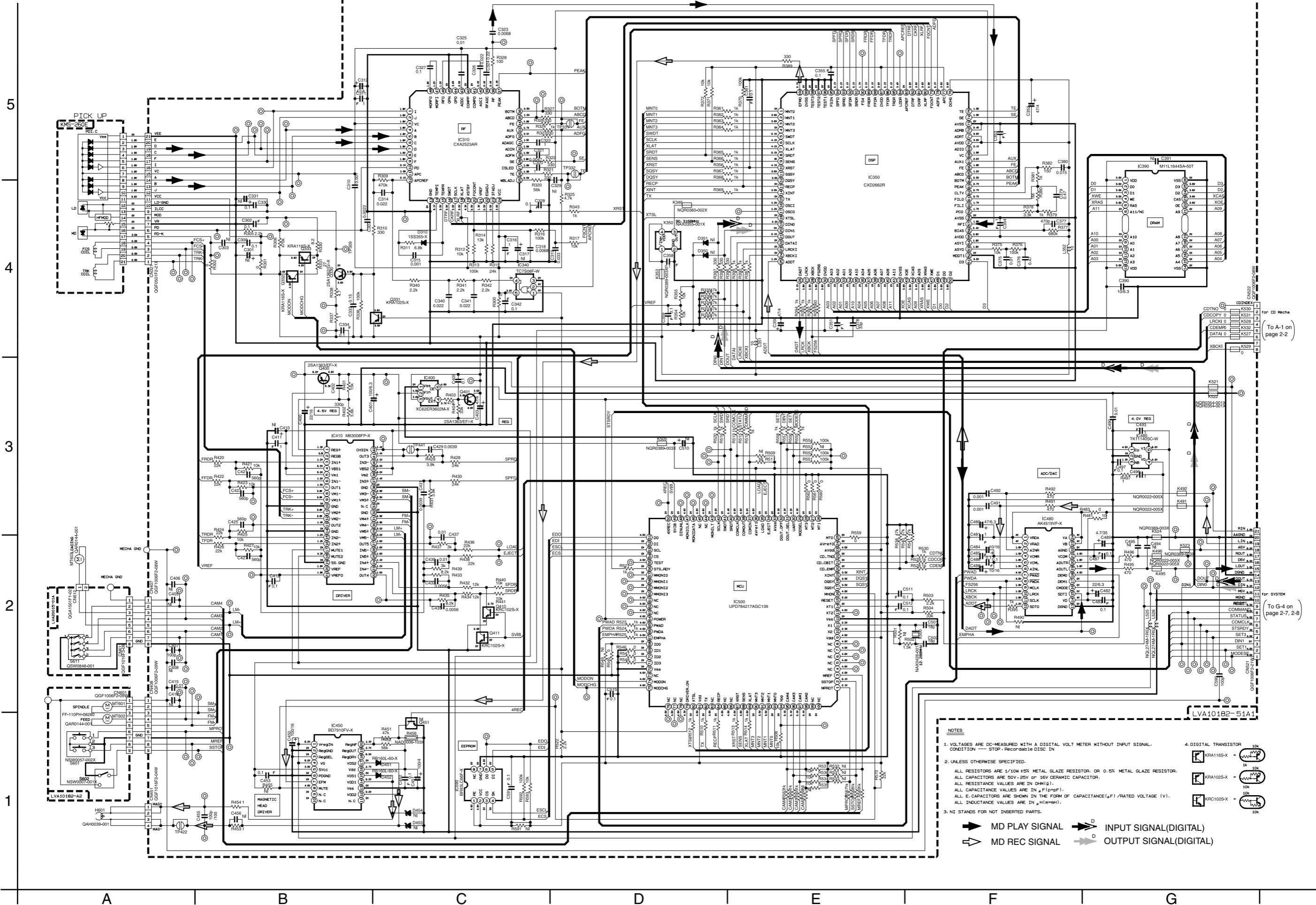

- NOTES**
1. VOLTAGES ARE DC-MEASURED WITH A DIGITAL VOLT METER WITHOUT INPUT SIGNAL.
CONDITION --- STOP, Recordable Disc IN.
 2. UNLESS OTHERWISE SPECIFIED.
ALL RESISTORS ARE 1/10W ±5% METAL GLAZE RESISTOR, OR 0.5% METAL GLAZE RESISTOR.
ALL CAPACITORS ARE 50V, 25V OR 16V CERAMIC CAPACITOR.
ALL RESISTANCE VALUES ARE IN Ω(M) (g).
ALL CAPACITANCE VALUES ARE IN μ(F)(pF).
ALL E-CAPACITORS ARE SHOWN IN THE FORM OF CAPACITANCE(μF)/RATED VOLTAGE (V).
ALL INDUCTANCES ARE IN μH(mH).
 3. NT STANDS FOR NOT INSERTED PARTS.
 4. DIGITAL TRANSISTOR
- KRA116S-X
 KRA120S-X
 KRC102S-X
- MD PLAY SIGNAL
 MD REC SIGNAL
 INPUT SIGNAL(DIGITAL)
 OUTPUT SIGNAL(DIGITAL)

To A-1 on page 2-2

To G-4 on page 2-7, 2-8

CD control section

5

4

3

2

1

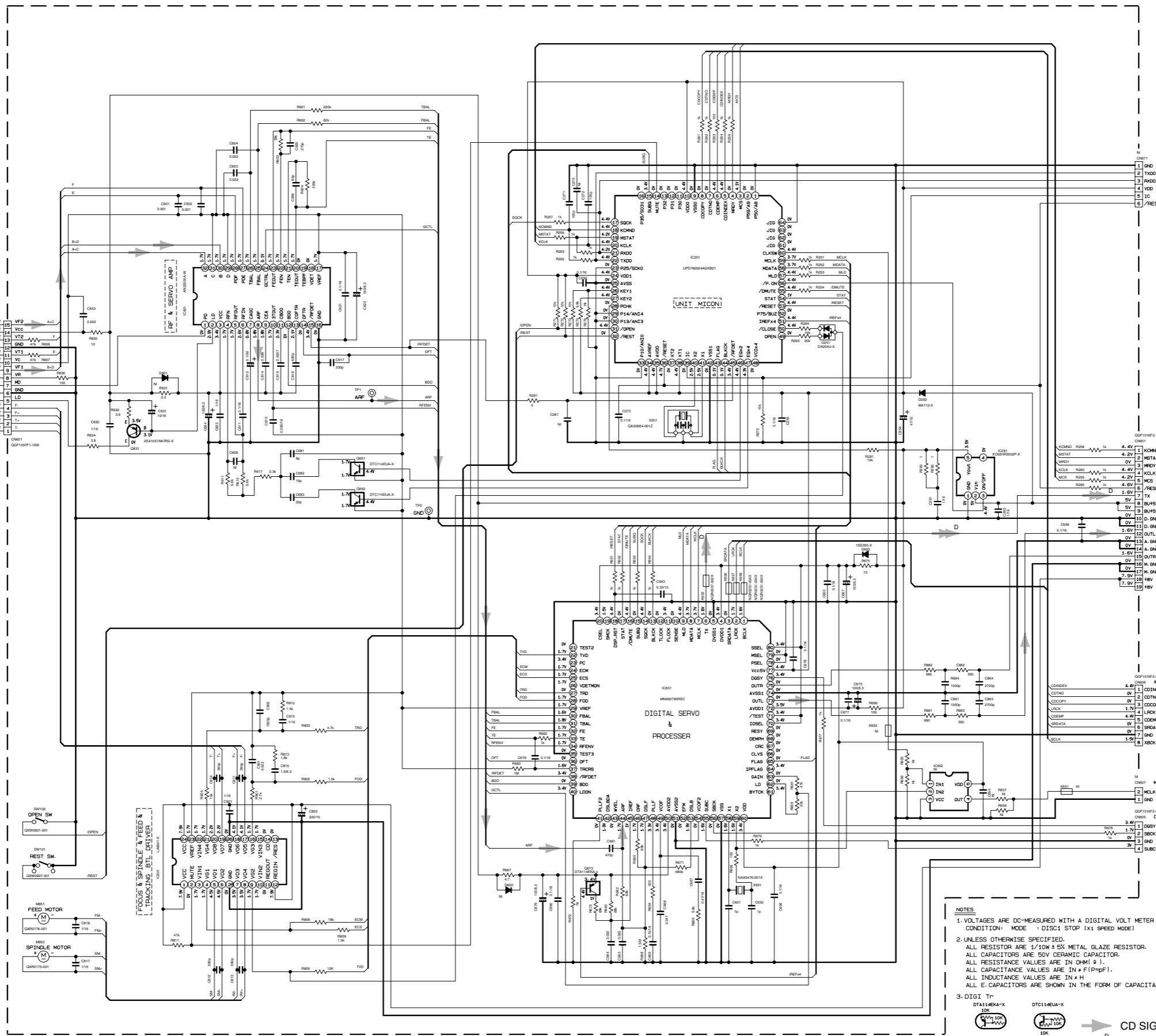
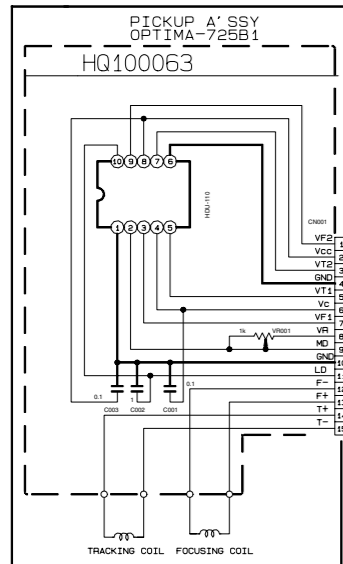

FOR FLASH MICON

TO AMP

(To G-3 on page 2-7, 2-8)

(To A-2 on page 2-2)

- NOTES
- VOLTAGES ARE DC-MEASURED WITH A DIGITAL VOLT METER
CONDITION: MODE : DISC1 STOP (x1 SPEED MODE)
 - UNLESS OTHERWISE SPECIFIED.
ALL RESISTOR ARE 1/10W ± 5% METAL GLAZE RESISTOR.
ALL CAPACITORS ARE 50V CERAMIC CAPACITOR.
ALL RESISTANCE VALUES ARE IN OHM (Ω).
ALL CAPACITANCE VALUES ARE IN μF (PpF).
ALL INDUCTANCE VALUES ARE IN μH.
ALL E-CAPACITORS ARE SHOWN IN THE FORM OF CAPACITANCE (μF)/RATED VOLTAGE (V).
 - DIGI TP
DT1146A-X
DT1146B-X
- CD SIGNAL
OUTPUT SIGNAL(DIGITAL)

■ Main amplifier, power amplifier, power supply section (A/US/UB/UP version)

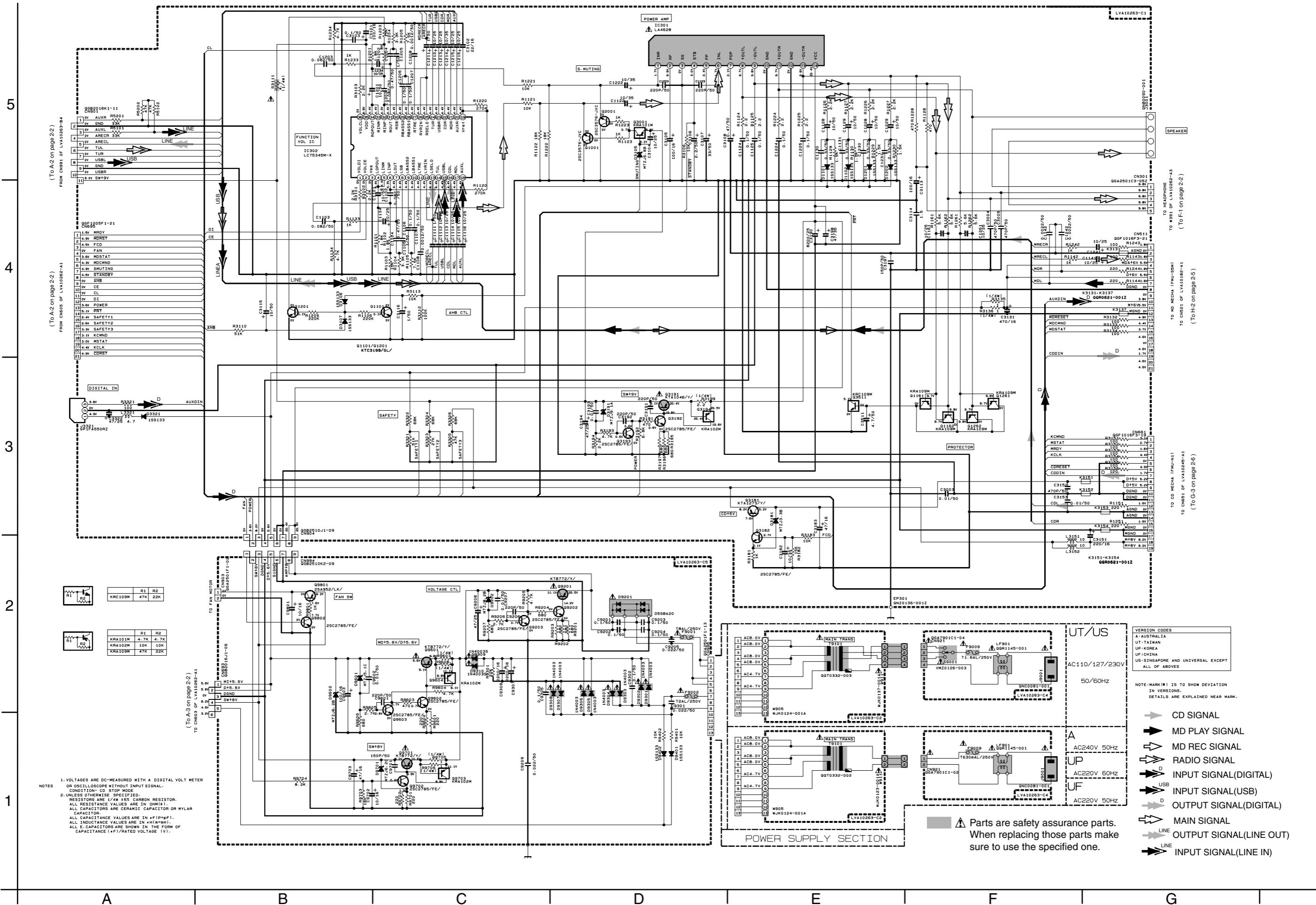

(To A-2 on page 2-2)
FROM CN91 OF LV10263-84

(To A-2 on page 2-2)
FROM CN93 OF LV10263-84

(To A-3 on page 2-2)
TO CN93 OF LV10263-84

(To A-3 on page 2-2)
TO CN93 OF LV10263-84

(To A-3 on page 2-2)
TO CN93 OF LV10263-84

(To A-3 on page 2-2)
TO CN93 OF LV10263-84

TO US/PHONE
TO #291 OF LV10263-43
(To F-1 on page 2-2)

TO MD MECHA (FNU-58W)
TO CN91 OF LV10263-84
(To H-2 on page 2-5)

TO CD MECHA (FNU-41)
TO CN91 OF LV10263-84
(To G-3 on page 2-6)

VERSION CODES

A	AUSTRALIA
UT	TAIWAN
UP	KOREA
UF	CHINA
US	SINGAPORE AND UNIVERSAL EXCEPT ALL OF ABOVE

NOTE: MARK (M) IS TO SHOW DEVIATION IN VERSIONS. DETAILS ARE EXPLAINED NEAR MARK.

- ➡ CD SIGNAL
- ➡ MD PLAY SIGNAL
- ➡ MD REC SIGNAL
- ➡ RADIO SIGNAL
- ➡ INPUT SIGNAL(DIGITAL)
- ➡ USB
- ➡ INPUT SIGNAL(USB)
- ➡ OUTPUT SIGNAL(DIGITAL)
- ➡ MAIN SIGNAL
- ➡ OUTPUT SIGNAL(LINE OUT)
- ➡ INPUT SIGNAL(LINE IN)

⚠ Parts are safety assurance parts. When replacing those parts make sure to use the specified one.

- NOTES
- VOLTAGES ARE DC-MEASURED WITH A DIGITAL VOLT METER OR OSCILLOSCOPE WITHOUT INPUT SIGNAL. CONDITION: CD STOP MODE.
 - UNLESS OTHERWISE SPECIFIED, RESISTORS ARE 1/4W ±5% CARBON RESISTOR. ALL RESISTANCE VALUES ARE IN Ω(M). ALL CAPACITORS ARE CERAMIC CAPACITOR OR MYLAR CAPACITOR. ALL CAPACITANCE VALUES ARE IN μF(μF). ALL INDUCTANCE VALUES ARE IN mH(mH). ALL E-CAPACITORS ARE SHOWN IN THE FORM OF CAPACITANCE (μF)/RATED VOLTAGE (V).

Main amplifier, power amplifier, power supply section (B/E/EN version)

5

4

3

2

1

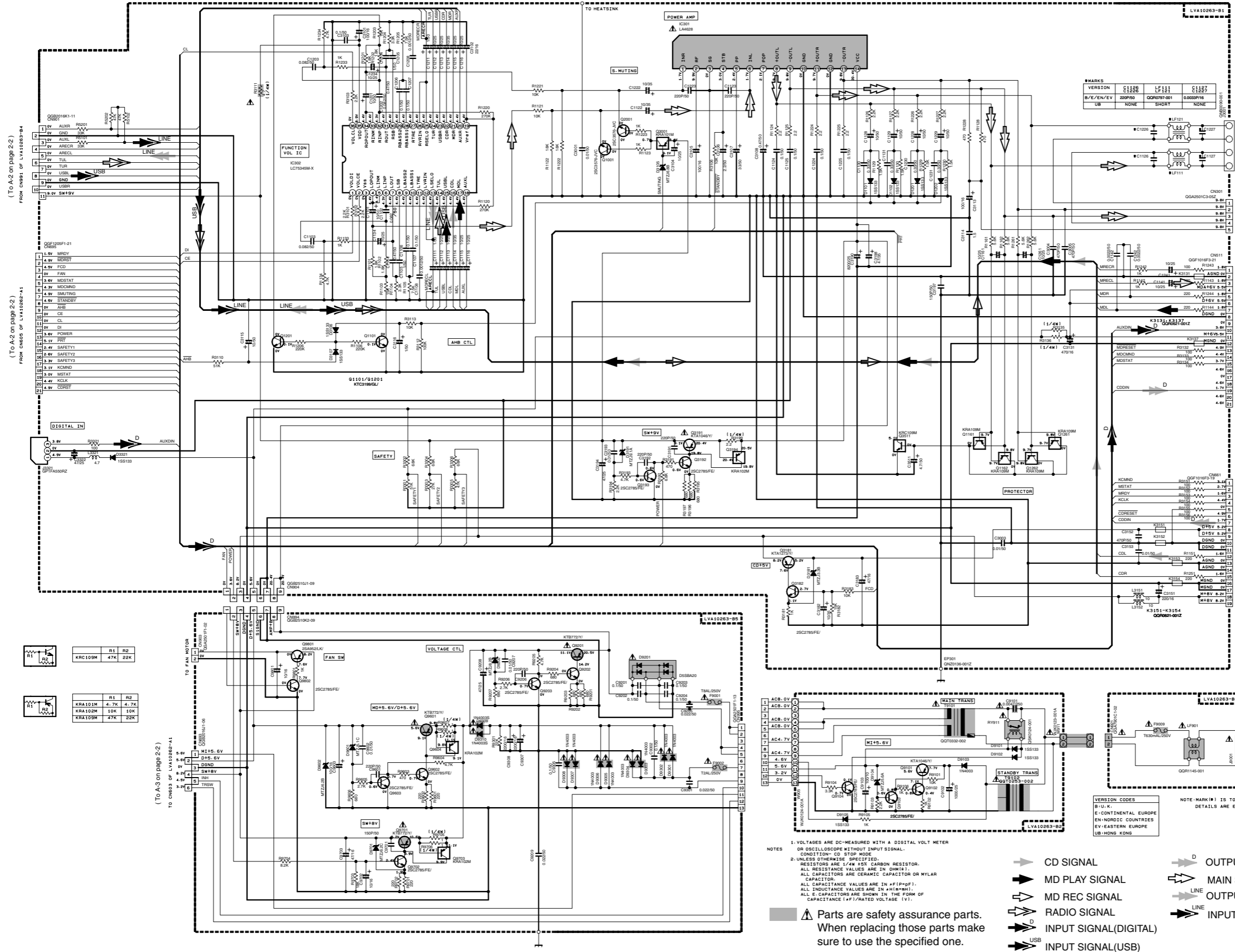

(To A-2 on page 2-2)
FROM CH03 OF LVA10263-B4

(To A-2 on page 2-2)
FROM CH03 OF LVA10263-A1

(To A-3 on page 2-2)
TO CH03 OF LVA10263-A1

TO HEADPHONE
TO K351 OF LVA10263-A3
(To F-1 on page 2-2)

TO MD MECH (FPU-N1)
TO CH01 OF LVA10263-A1
(To H-2 on page 2-5)

TO CD MECH (FPU-N1)
TO CH01 OF LVA10263-A1
(To G-3 on page 2-6)

MARKING	VERSION	C1108	LF111	C1107
B/E/EN/EV	200902	Q00000001	Q00000001	Q00000001
UB	NONE	SHORT	SHORT	NONE

VERSION CODES	
B-U-K	CONTINENTAL EUROPE
EN-NORDIC	NORDIC COUNTRIES
EV	EASTERN EUROPE
UB	HONG KONG

NOTE: MARK (R) IS TO SHOW DEVIATION IN VERSIONS. DETAILS ARE EXPLAINED NEAR MARK.

- NOTES
- VOLTAGES ARE DC-MEASURED WITH A DIGITAL VOLT METER OR OSCILLOSCOPE WITHOUT INPUT SIGNAL. CONDITION - CD STOP MODE.
 - UNLESS OTHERWISE SPECIFIED, RESISTORS ARE 1/4W ±5% CARBON RESISTOR. ALL RESISTANCE VALUES ARE IN OHMS (Ω). ALL CAPACITORS ARE CERAMIC CAPACITOR OR MYLAR CAPACITOR. ALL CAPACITANCE VALUES ARE IN pF (pF). ALL INDUCTANCE VALUES ARE IN mH (mH). ALL E-CAPACITORS ARE SHOWN IN THE FORM OF CAPACITANCE (μF)/RATED VOLTAGE (V).
- CD SIGNAL
 - MD PLAY SIGNAL
 - MD REC SIGNAL
 - RADIO SIGNAL
 - INPUT SIGNAL(DIGITAL)
 - INPUT SIGNAL(USB)
 - OUTPUT SIGNAL(DIGITAL)
 - MAIN SIGNAL
 - OUTPUT SIGNAL(LINE OUT)
 - INPUT SIGNAL(LINE IN)

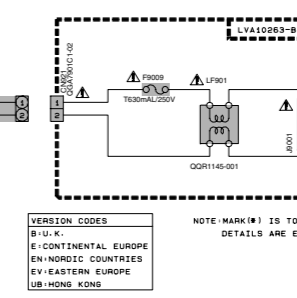
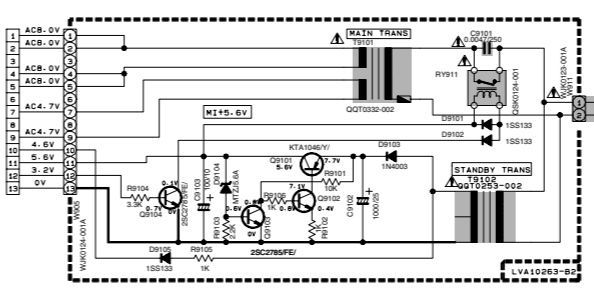

Printed circuit board

■ System control board

5
4
3
2
1

(Display support board)

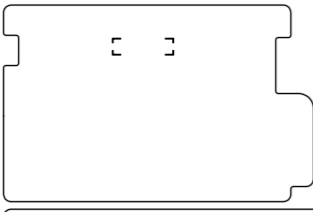

(Earth plate board)

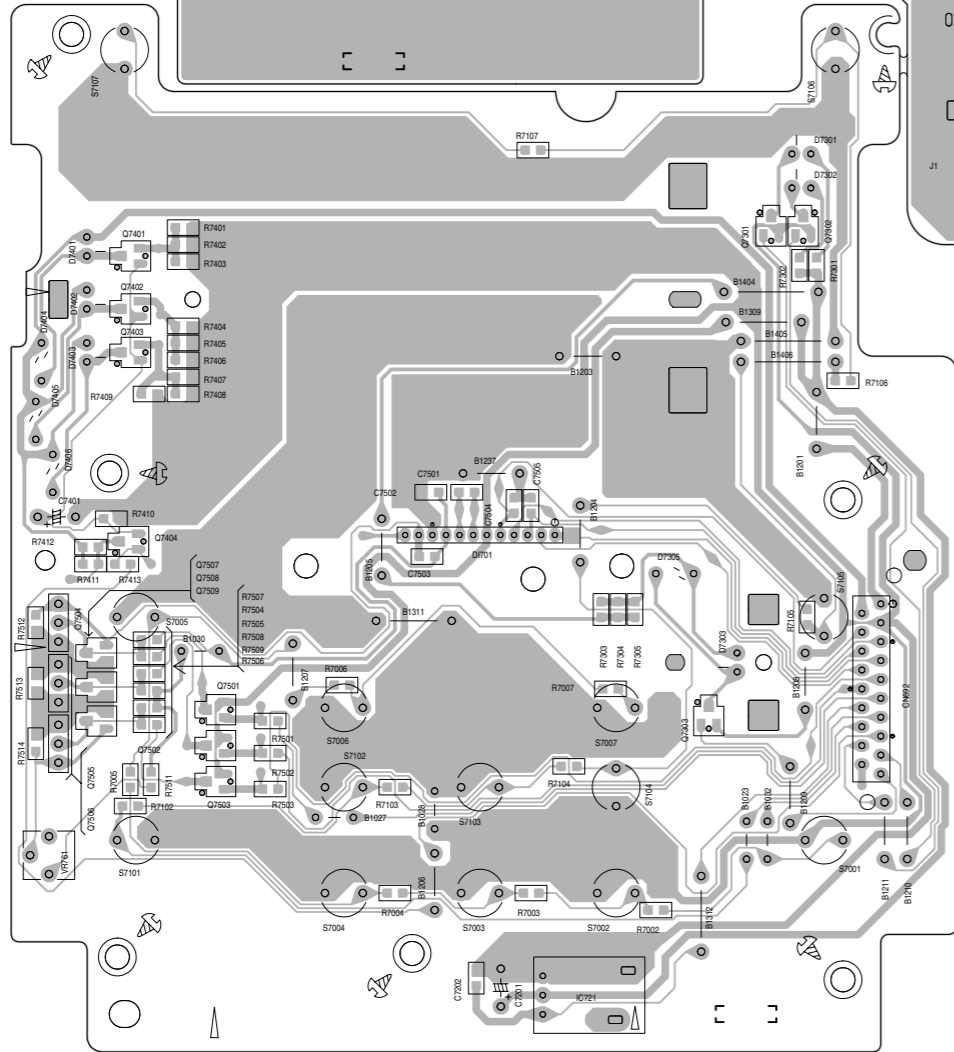
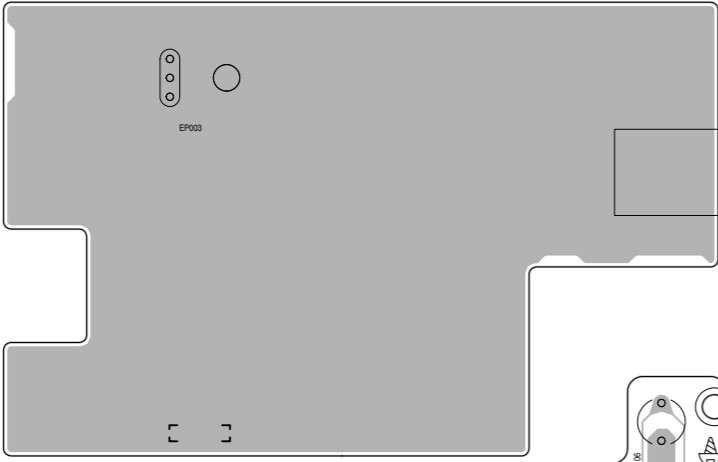

(Front board)

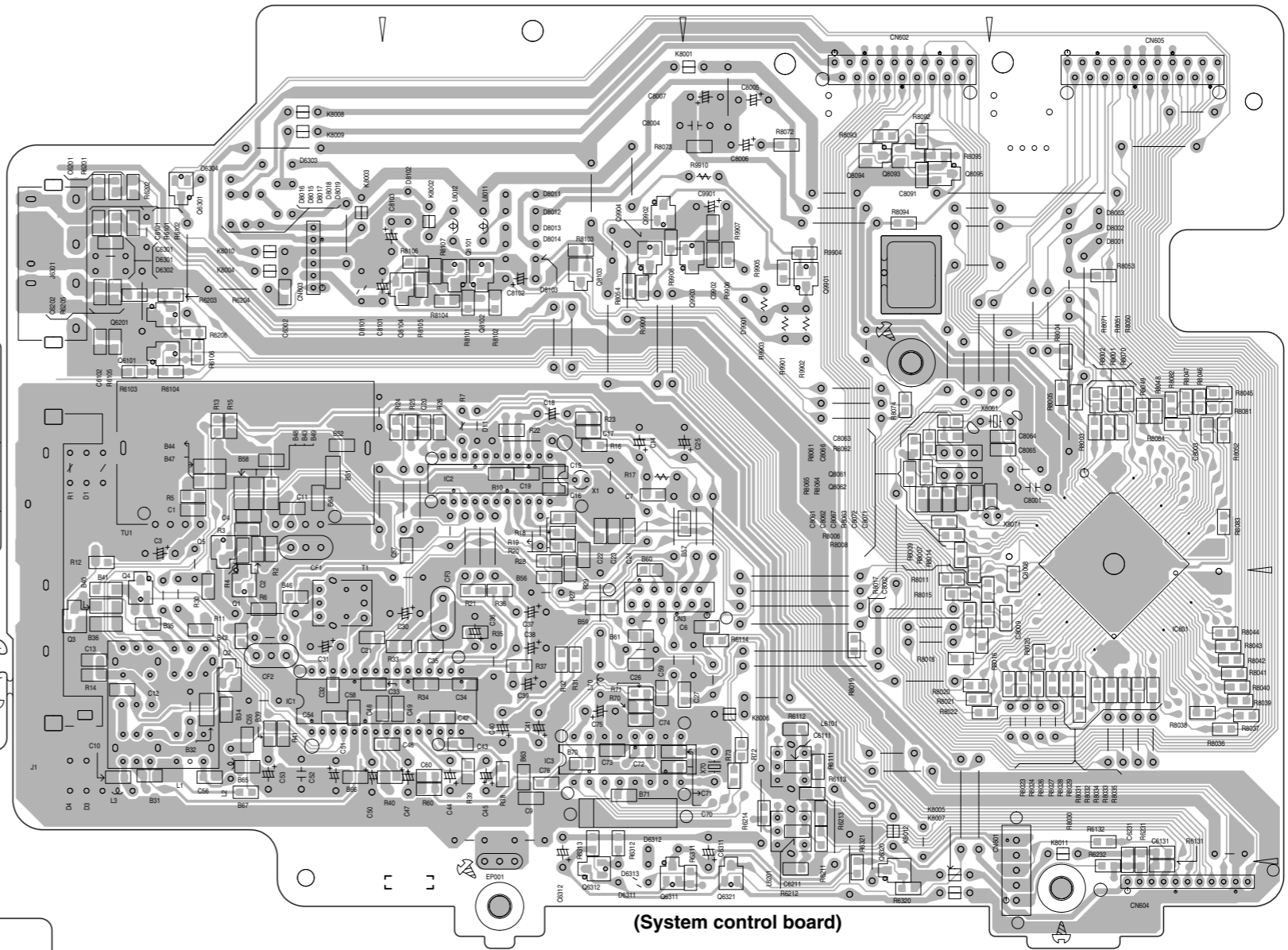

(System control board)

(Head phone & USB board)

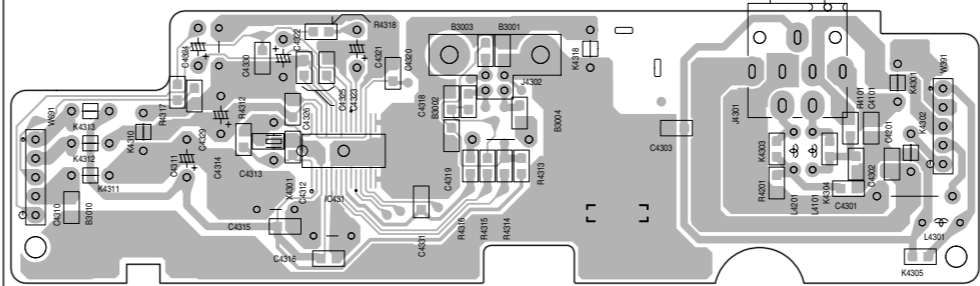

(Card wire support board)

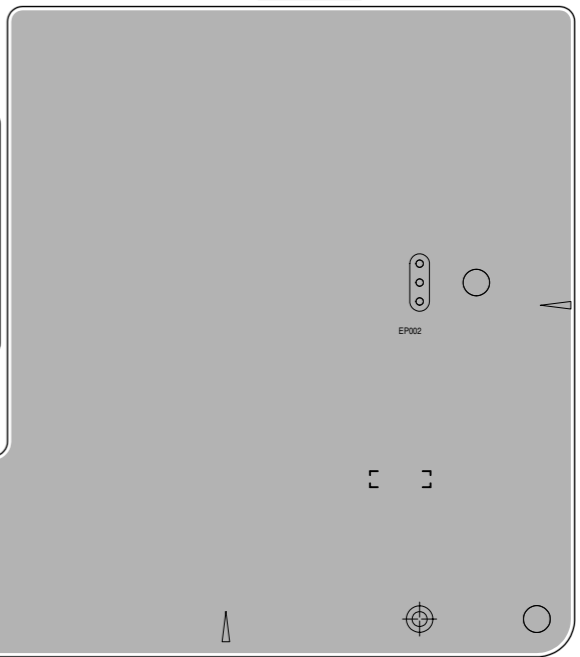

A

B

C

D

E

F

G

■ Main amplifier board

(Main amplifier board)

5

4

3

2

1

(AC jack board)

(Relay board)

(power amplifier board)

(power supply board)

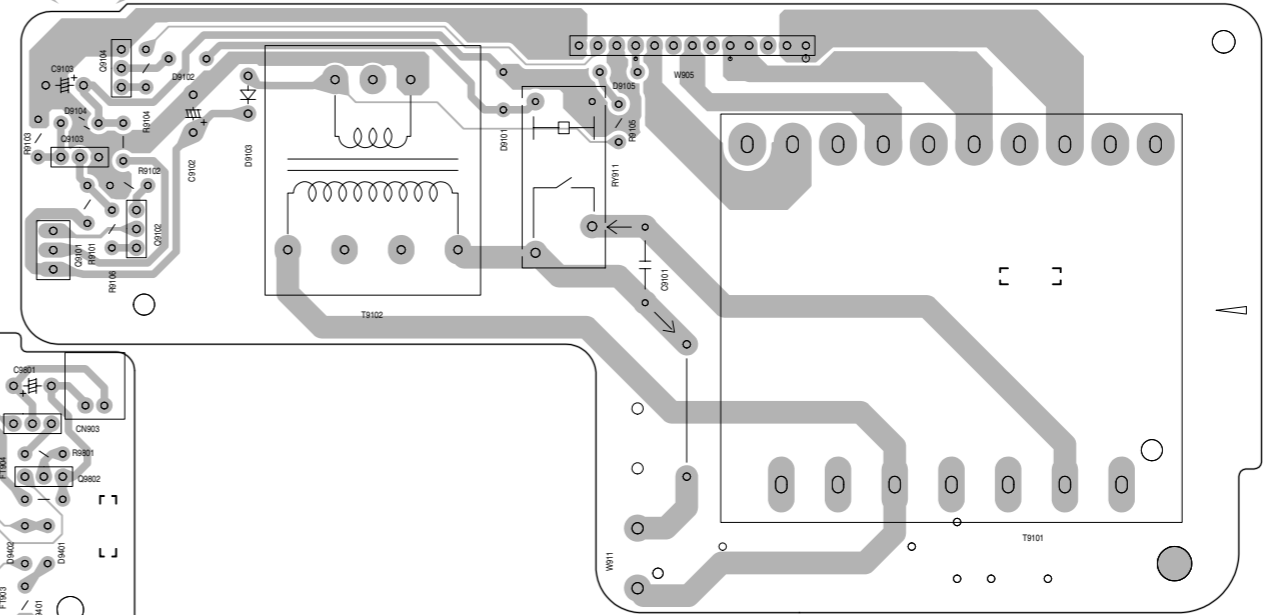
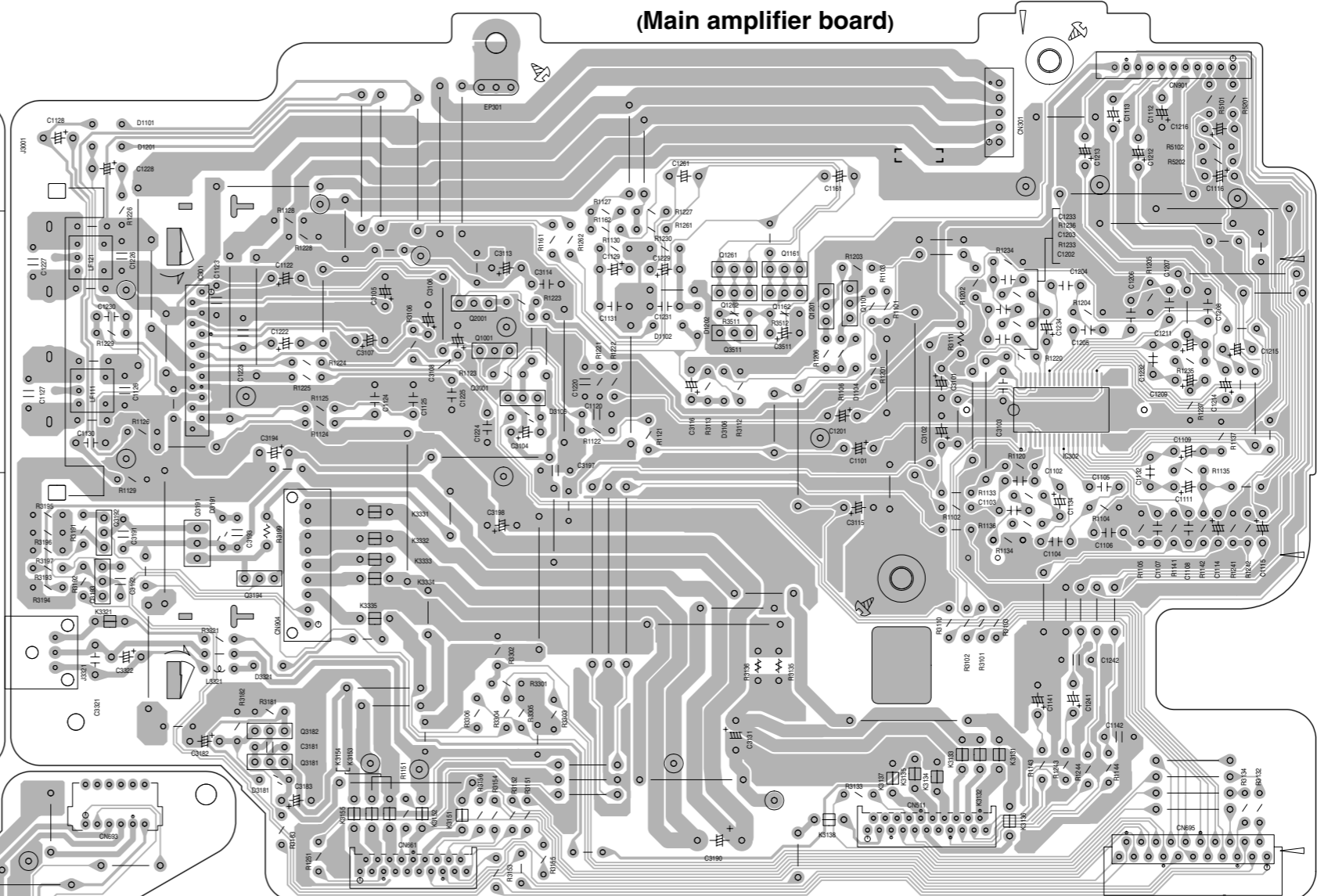
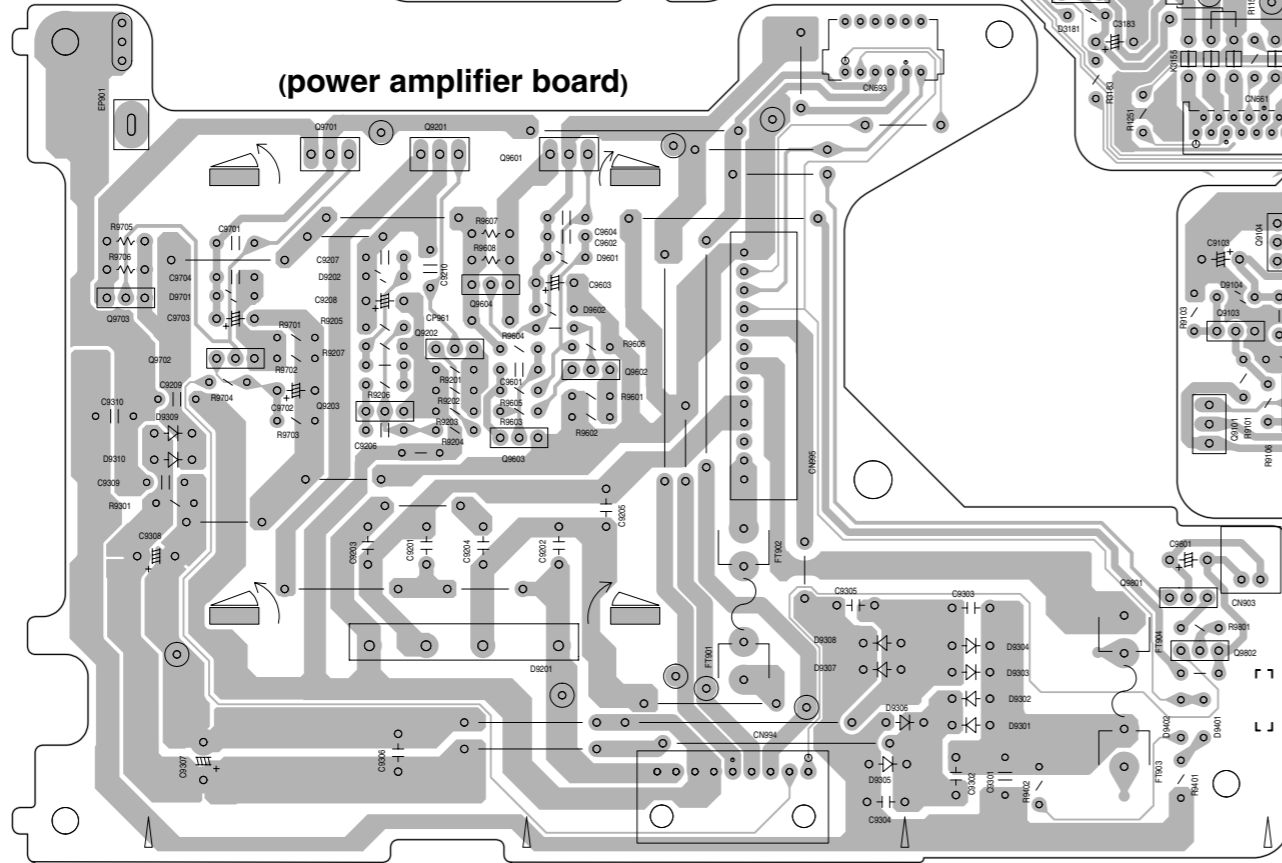
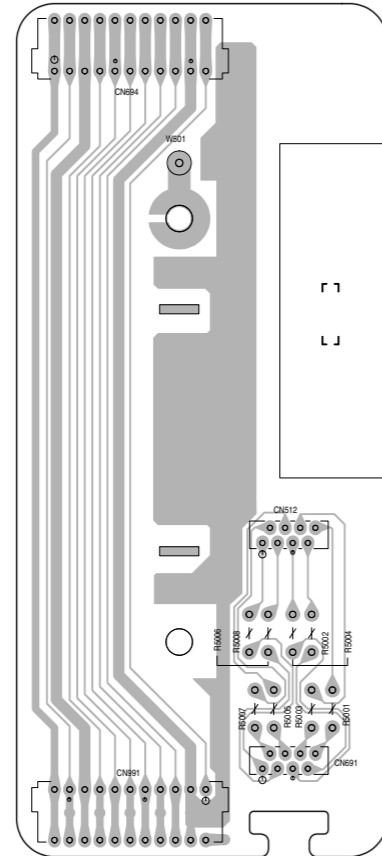
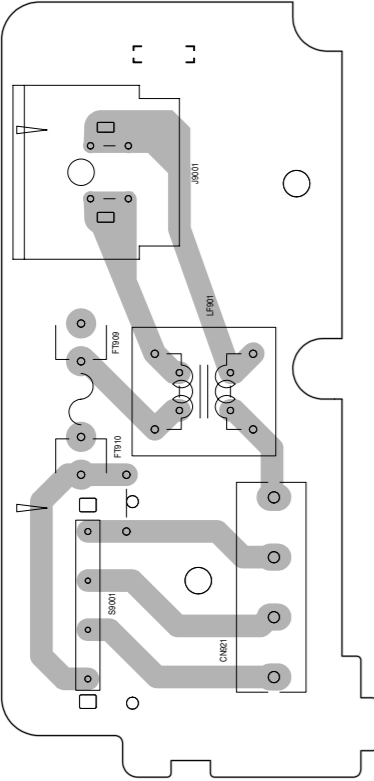

A

B

C

2-10

D

E

F

G

H

■ MD servo board

(Component side)

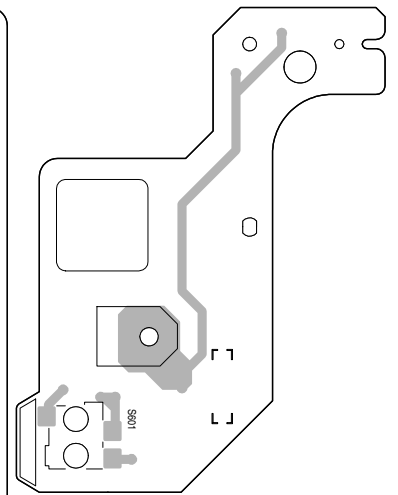
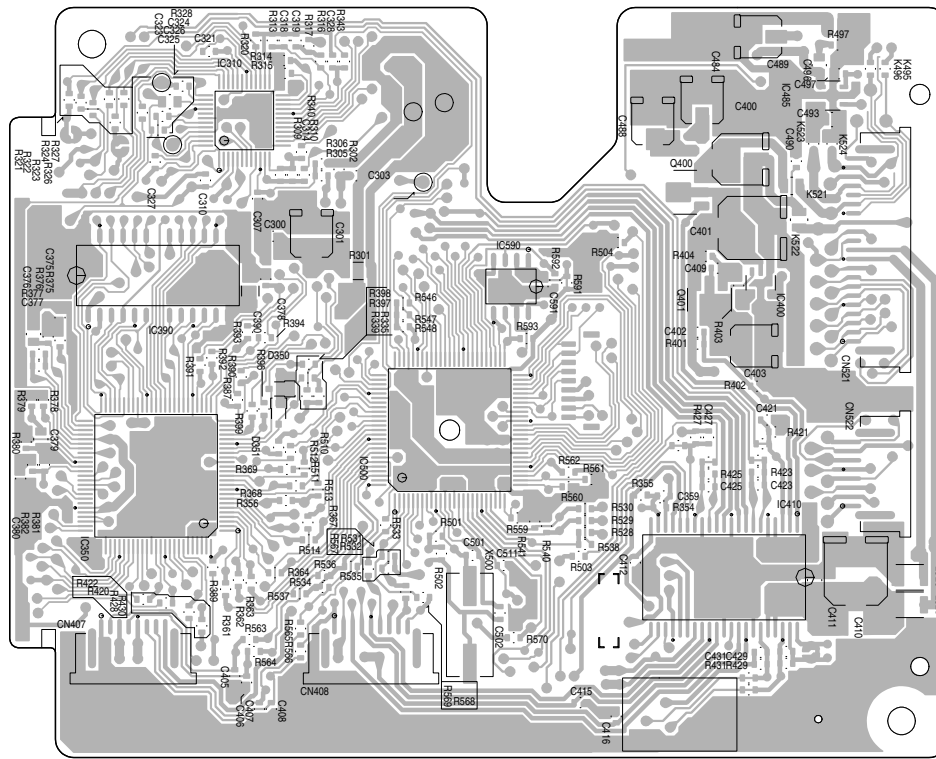

(Traverse mechanism board)

(Servo board)

(Solder side)

